

0 607 450 612

Issue
Stand 05-12-14 **Fig./Abb. 1**

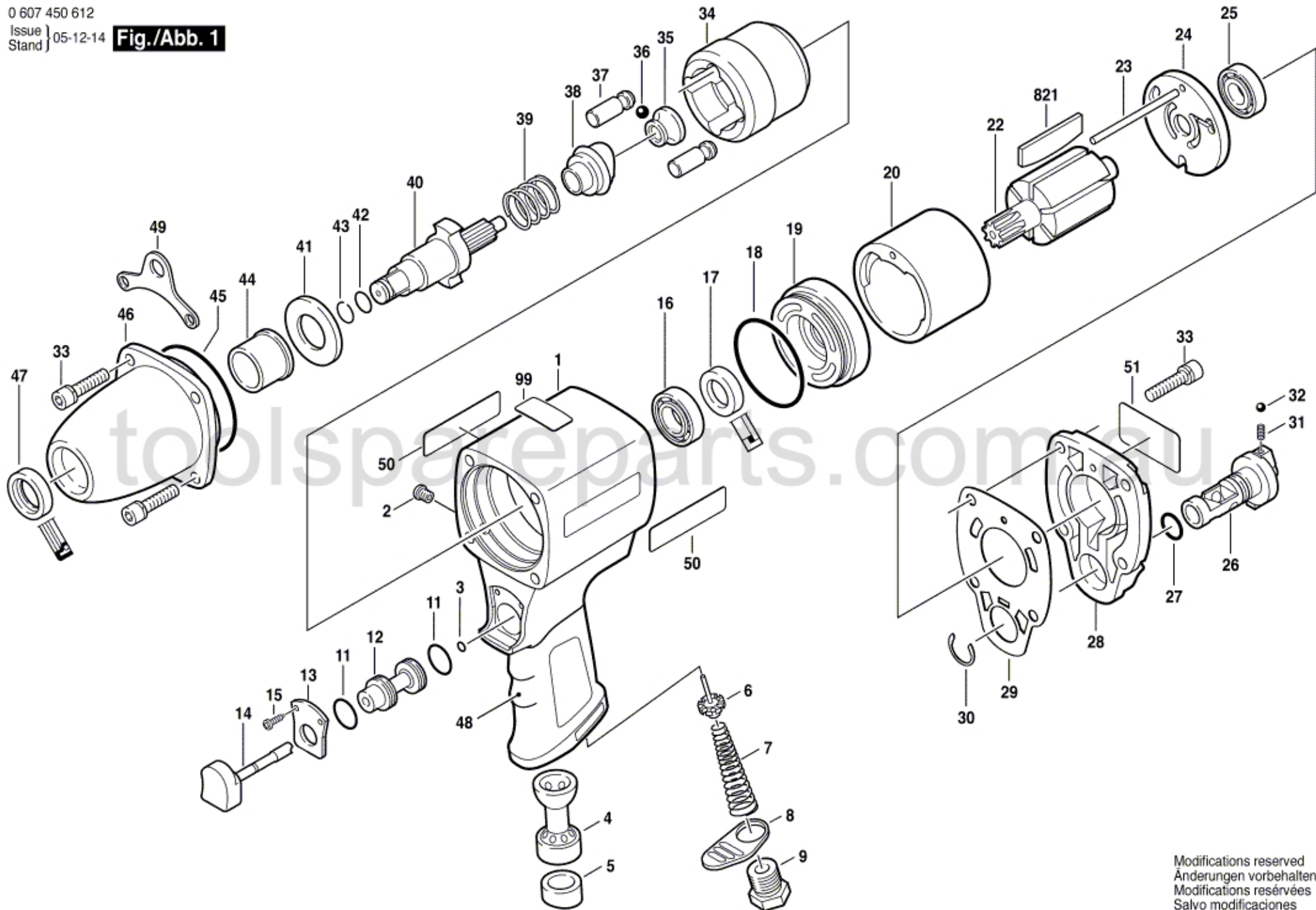

Modifications reserved
Änderungen vorbehalten
Modifications réservées
Salvo modificaciones